

F5-1

SERIES DU SLIP-ON DRYWALL FRAMES

FOR 1-3/4" THICK DOORS
HANDED

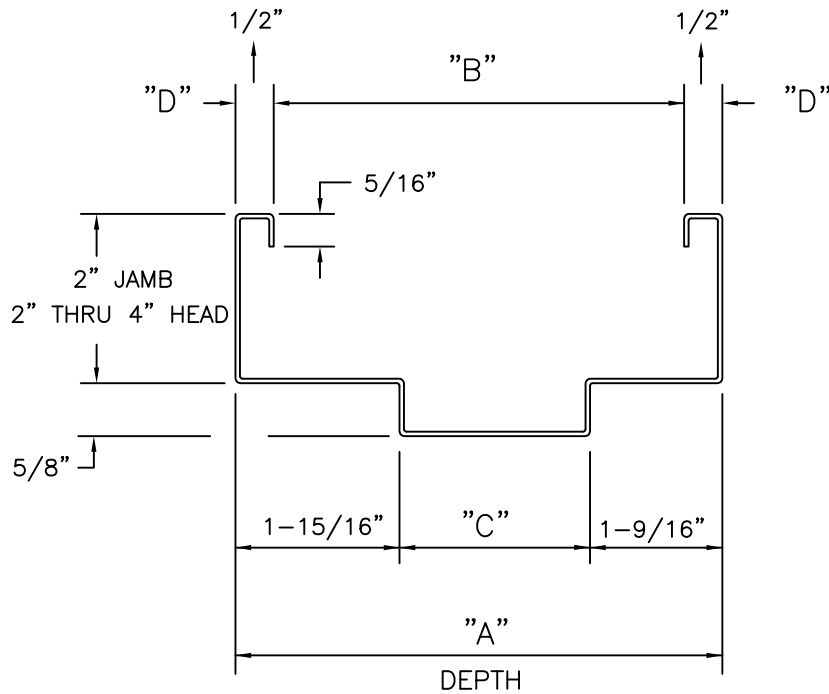

DEPTHS RANGING FROM 4-1/2" TO 14" ARE AVAILABLE.
DIMENSION "D" IS AVAILABLE IN 7/16", 9/16", & 5/8" ON CUSTOM DESIGNS.

10/25/13

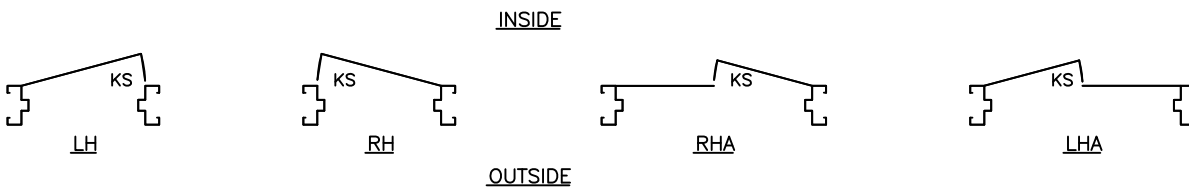

"KS" = KEY SIDE

SUFFIX "A" = ACTIVE LEAF OF PAIRS (Conversion: 1" = 25.4 mm, e.g., 1-3/4" = 44.45 mm)

F5-2

Hardware locations shown match Ceco standard doors.

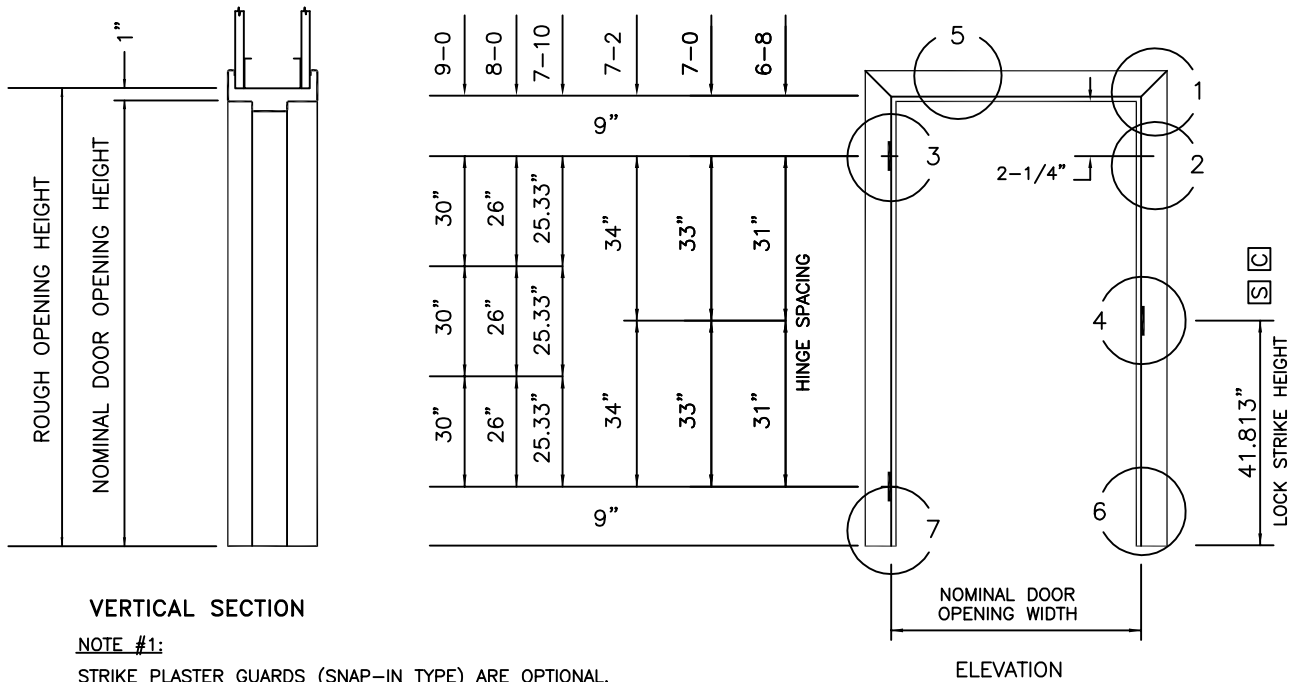

VERTICAL SECTION

NOTE #1:

STRIKE PLASTER GUARDS (SNAP-IN TYPE) ARE OPTIONAL.

□ 1" DEEP

- STEEL/WOOD STUD AND DRYWALL CONSTRUCTION METHODS, IN CONJUNCTION WITH FRAME ANCHORAGE, COULD RESULT IN INTERFERENCE BETWEEN THE STUD AND HARDWARE PREP. NOTCHING OF THE STUD COULD RESULT IN COMPROMISING THE STABILITY OF THE FRAME. CONSIDERATION SHOULD BE GIVEN TO SPECIFYING THE HARDWARE SUITABLY SIZED TO FIT THE CONFINES OF A STANDARD FRAME OR SPECIFYING ALTERNATE FRAME PROFILES TO ACCOMMODATE THE HARDWARE.
- IF NECESSARY TO REMOVE, PLASTER GUARDS ARE BEST REMOVED BEFORE FRAME INSTALLATION.

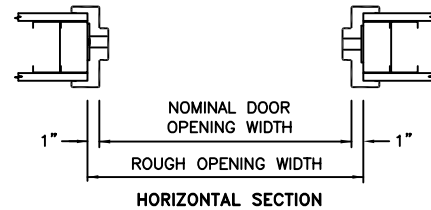

INSTALLATION INSTRUCTIONS

ROUGH OPENING:
DOOR OPENING WIDTH PLUS 2"
DOOR OPENING HEIGHT PLUS 1"

STEP 1

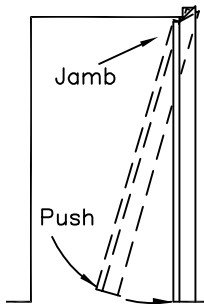

- PUSH TOP OF ONE JAMB OVER THE WALL.
- HOLD TOP OF JAMB IN PLACE, THEN PUSH BOTTOM IN TOWARDS AND OVER WALL.

STEP 2

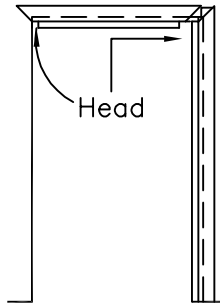

- POSITION FRAME HEAD OVER THE WALL.
- ALIGN HEAD TABS WITH JAMB SLOTS, THEN SLIDE HEAD TOWARD JAMB AND ENGAGE TABS IN SLOTS.

**STEP 3
LEVEL**

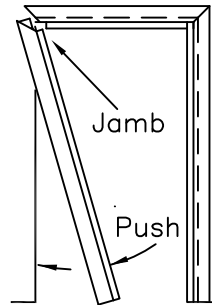

- PUSH TOP OF REMAINING JAMB OVER WALL AND MATE TABS IN SLOTS.
- PUSH BOTTOM OF JAMB IN TOWARDS AND OVER WALL.
- LEVEL HEAD.

**STEP 4
LEVEL**

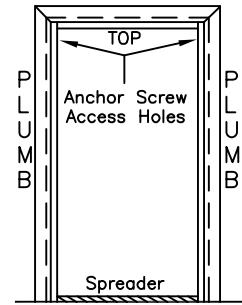

- ADJUST PLUMB ANCHORS WITH SCREWDRIVER.
- PLUMB HINGE JAMB AND ANCHOR SILL.
- WITH TEMPORARY SPREADER, ADJUST STRIKE JAMB AND ANCHOR SILL.
- INSTALL MUTES.

(Conversion: 1" = 25.4 mm, e.g., 1-3/4" = 44.45 mm)



01/15/14

TECH-DATA

SERIES DU DRYWALL FRAMES

F5-3

KNOCKED DOWN CORNER CONSTRUCTION

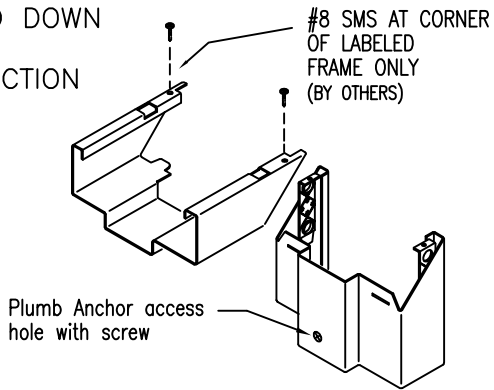

①

ADJUSTABLE PLUMB ANCHOR

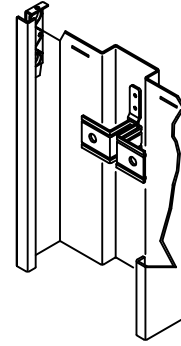

ONE EACH JAMB
Adjust with screwdriver

②

Dual plumb anchors are applied in depths greater than 8-3/4".

HINGE PREPARATION

4-1/2" x .134" OR
4-1/2" x .180"
ANSI A156.7 TEMPLATE
7 GAGE STEEL
REINFORCING

BACKSET: 5/16"

SEE NOTE #1

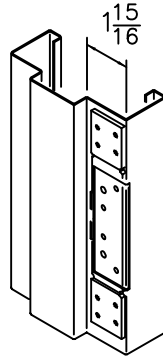

③

STRIKE PREPARATION

UNIVERSAL (4-7/8")
ANSI A115.1 & 2 TEMPLATE
12 GAGE STEEL REINFORCING
STANDARD FOR 1-3/4" DOORS

SEE NOTE #1

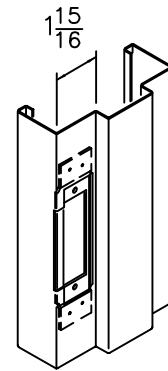

④

LOCK STRIKE PREPARATION

CYLINDRICAL (2-3/4")
ANSI A115.2 TEMPLATE
14 GAGE STEEL REINFORCING
ALSO AVAILABLE WITHOUT
LIP CUTOUT FOR DEADLOCKS

SEE NOTE #1

C

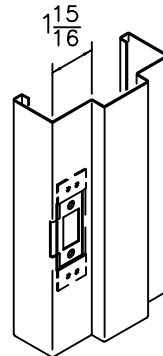

④

CLOSER REINFORCEMENT (OPTIONAL)

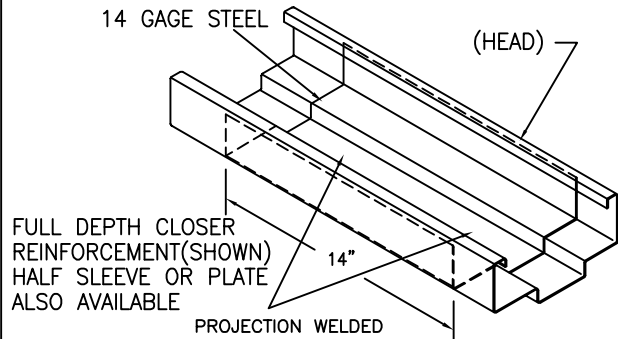

⑤

DOOR SILENCER (MUTE)

RUBBER MUTE
(3) / STRIKE JAMB
(2) / DOUBLE
SWING HEAD

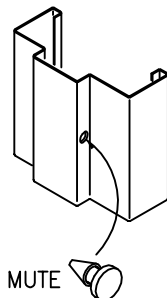

STANDARD SILL ANCHOR

DIMPLED HOLE FOR #10 FH FASTENER. FASTENER IS BY CONTRACTOR AND MUST BE LONG ENOUGH TO ENGAGE STUD.

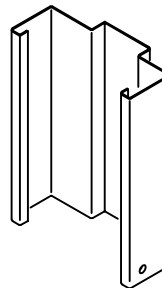

⑥

OPTIONAL SILL STRAP ANCHOR

FASTENER IS BY CONTRACTOR AND MUST ENGAGE STUD.

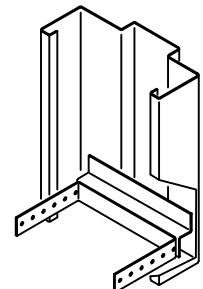

⑦

(Conversion: 1" = 25.4 mm, e.g., 1-3/4" = 44.45 mm)

01/15/14

F5-4

STANDARD SIZES NOMINAL DOOR OPENING

WIDTH		HEIGHT
SINGLE	DOUBLE	
2'-0"	4'-0"	6'-8" 7'-0" 7'-2" 7'-10" 8'-0" 9'-0"
2'-4"	4'-8"	
2'-6"	5'-0"	
2'-8"	5'-4"	
2'-10"	5'-8"	
3'-0"	6'-0"	
3'-4"	6'-8"	
3'-6"	7'-0"	
3'-8"	7'-4"	
3'-10"	8'-0"	
4'-0"		

FIRE DOOR FRAMES

LABELING AGENCIES:

- UNDERWRITERS LABORATORY
- WARNOCK HERSEY
- FACTORY MUTUAL

TEST: UL 10C, UL 10B,
UL 1784, & NFPA 252

- RATING: 20 MIN, 3/4 HR,
OR 1-1/2 HR

- MAX. SIZE: 14 GAGE STEEL
16 GAGE STEEL
40 x 90 SINGLE
80 x 90 PAIR
- 18 GAGE STEEL
40 x 70 SINGLE
610 x 70 PAIR

NOT ALL RATINGS ARE AVAILABLE
IN ALL SIZES, DESIGNS AND
MATERIALS.

PRODUCT SPECIFICATIONS:

Steel door frames shall be as manufactured by Ceco Door, Milan, TN or Mason City, IA, USA. They shall conform to the Steel Door Institute guide specification, ANSI A250.8-1998. See chart below for performance classifications.

Series DU frames for 1-3/4" doors are formed from commercial quality cold rolled steel conforming to ASTM A1008 ...or (optional) hot-dipped galvanized steel conforming to ASTM A924 and A653 - see chart below.

Frames are knocked down, field assembled type. Components have diecut mitered corners that interlock rigidly when field assembled. Double rabbet profiles are sized to fit 3 popular wall thicknesses. Integral door stops are 5/8" high and frame faces are 2". Adjustable, compression type anchors are welded to jambs and allow frame installation, plumbing and squaring after wallboard is applied (to adjust anchors use Phillips head screw driver). Components have backbend-returns that protect the wall surface during installation. Sill anchoring is by means of screws through dimpled holes in faces ... welded on sill strap anchors are also available (optional).

Hardware Provisions: Frames are handed. Hinge jambs are mortised for 4-1/2" high, standard or heavy weight hinges (specify which). 7 gage steel reinforcements are welded in place and are drilled and tapped for fasteners in accordance with ANSI A156.7. The strike jamb is prepared for 4-7/8" universal or 2-3/4" cylindrical strike in accordance with ANSI A 115.1&2 (specify which). Optional closer reinforcement is a 14 gage steel formed steel sleeve. 3 mute holes are provided per strike jamb and 2 for double swing heads.

Paint: Steel door frames are provided with one coat of oven-cured neutral color primer paint. Primer coat shall conform with ANSI A250.10. The primer coat is a preparatory base for necessary finish painting. "Colorstyle" finish coat is also available. Colorstyle finish is electrostatically applied, oven-cured urethane enamel. For accurate color selector chart ask customer service for a Pantone Colorstyle chart.

MATERIAL

DOOR FRAME MATERIAL	LEVEL	C.R.	GALV	
			A60	G90
18 Gage Steel	Standard Duty	STD	OPT	N/A
16 Gage Steel	Standard, Heavy, or Extra Heavy Duty	STD	OPT	OPT
14 Gage Steel	Maximum Duty	STD	OPT	OPT

18 gage steel for use with 1-3/4" wood doors.

Also available in 18 gage steel for 1-3/8" doors ...Ask for details

PERFORMANCE

Physical Endurance Level:	Meets ANSI A250.4 Performance Test -- 16 & 14 gage steel: Level A (1,000,000 Cycles)
---------------------------	--

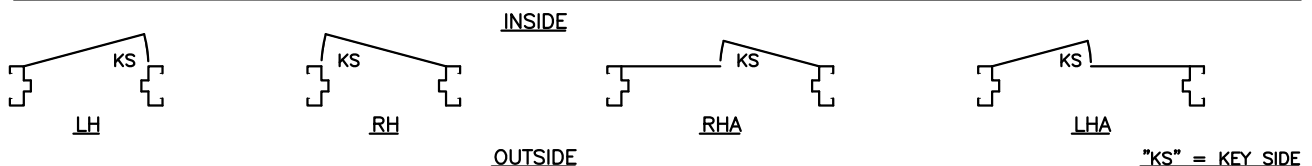

SUFFIX "A" = ACTIVE LEAF OF PAIRS

(Conversion: 1" = 25.4 mm, e.g., 1-3/4" = 44.45 mm)

CecoDoor

ASSA ABLOY

ASSA ABLOY, the global leader
in door opening solutions.

03/07/17