

B Series



About the product

Steelcraft B18, B16, and B14 Series flush doors are designed to meet the architectural requirements for full flush, steel stiffened doors. The door face sheets are supported by the internal steel stiffeners, which extend the full door width. The stiffeners are welded to (1) face sheet and bonded to the opposite panel.

The B Series Door offers a wide range of specifiable options including sizes, glass light designs, optional edge constructions and hardware (mechanical, pneumatic, electrical) preparations.

B Series doors are 1 3/4" (45 mm) thick.

THE USE OF HIGH GLOSS PAINT IS NOT RECOMMENDED.

High gloss paint accentuates the visibility of all welds.

Installation

1. Installation shall conform to the published Steelcraft installation instructions, ANSI A250.11-2012 (formerly SDI 105) *Recommended Erection Instructions for Steel Frames and HMMA 840*.
2. Fire Rated Assemblies must be in accordance with NFPA Pamphlet 80. The *Authority Having Jurisdiction* is the final authority on issues related to the installation and use of installed Fire Rated Doors.
3. See Sound Openings section on page 243 for optional B-Door construction.

Note 1: For optional B-Door construction with STC-Stiffened Core, see SPECIALTY PRODUCTS: SOUND OPENINGS section page 243.

Features and benefits

Steelcraft's B Series doors offer the following standard unique features, which enhance long term performance and durability:

1. **Steel Stiffened core construction** with welded 20 gauge hat section stiffeners.
2. **Full Height, Epoxy Filled Mechanical Interlock Edges** provide structural support and stability the full height of the door edges. Available edge options:
 - **Visible Edge Seam (standard):** full height, epoxy filled mechanical Interlocked edges
 - **Filled Edge Seam (optional add to standard):** seam filled with structural adhesive and dressed smooth. Includes tack welds above and below edge cutouts for hinges, locks, etc.
 - **Welded Edge Seam (optional add to standard):** intermittently welded using 1" long welds, then seam filled with structural adhesive and dressed smooth. Option available on B18, B16 and B14 doors.
3. **Universal Hinge Preparations** (patented) allow for easy field conversion from standard weight .134" (3.3 mm) hinges to heavy weight .180" (4.7 mm) hinges.

14 Gauge [0.067" (1.7 mm)] Inverted Top and Bottom Channels provide stability and protection for the top and bottom edges from abuse.
4. **Beveled Hinge and Lock Edges** allow for tighter installation tolerances, ensure easier operation and eliminate binding and sticking.
5. **Recessed Dezigner™ Glass Trim** provides a clean, neat and flush finish with the door surface.
6. **Factory Applied Baked-On Rust Inhibiting Primer** paint in accordance with ANSI A250.10-2011.

Specification compliance

1. Door construction for Steelcraft B Series full flush doors meets the requirements of ANSI A250.8-2014 (SDI 100).
2. Hardware preparations and reinforcements are in accordance with ANSI A250.6-2003 (R2009). Locations are in accordance with ANSI/DHI A115 unless otherwise stated.

Fire ratings

B Series doors meet the broadest fire rating requirements. They are listed for installations requiring compliance to both neutral pressure testing (ASTM E152 and UL-10B) and positive pressure standards (UL-10C).

Core construction

Steel Stiffeners with Fiberglass Insulation

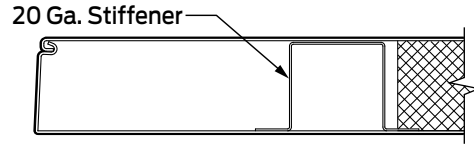
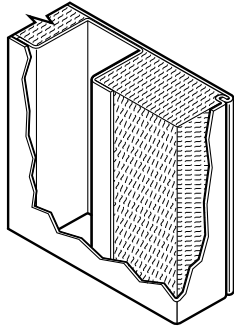

Standard B Series Core

- 20 gauge stiffeners
- Stiffeners welded to inside of (1) face sheet and bonded to the opposite face
 - Vertical interior webs located 6" (152 mm) apart
 - Weld spacing 5" (152 mm) on center along the full height of each stiffener
- Stiffener height extends full height of door thickness
- Areas between stiffeners filled with nominal 1 pound (453.6g) per ft³ density fiberglass batt insulation
- For optional B-Door construction with STC-Stiffened Core, see SPECIALTY PRODUCTS: SOUND OPENINGS on page 245.

Standard Premium Edge Construction

- Beveled hinge & lock edges
- Full height mechanical interlock with epoxy adhesive
- Visible edge seam standard
- Seamless edge optional

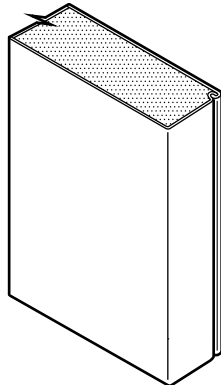

Standard Rigid 14 Gauge End Channel Construction

- 14 gauge inverted galvanized top & bottom channels
- Projection welded to both face sheets
- For optional caps, see ["Weather seals" on page 145.](#)

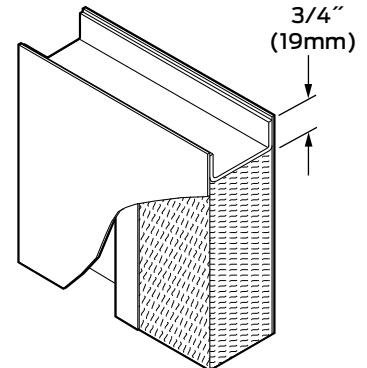

Door application and usage			
Series	Steel Thickness	Opening	Usage Frequency
B18	18 Ga (1.0 mm)	Interior: Cold Rolled Steel	Heavy Duty
B18	18 Ga (1.0 mm)	Exterior: Galvanized Steel	Heavy Commercial & Institutional applications with high use
B16	16 Ga (1.3 mm)	Interior: Cold Rolled Steel	Extra Heavy Duty
B16	16 Ga (1.3 mm)	Exterior: Galvanized Steel	Extra Heavy Commercial applications with potential of very high use
B14	14 Ga (1.7 mm)	Interior: Cold Rolled Steel	Maximum Duty
B14	14 Ga (1.7 mm)	Exterior: Galvanized Steel	Extra Heavy Commercial applications with extremely high use

Standard hardware preparations

Typical hardware applications shown. Refer to "Hardware" section for more details.

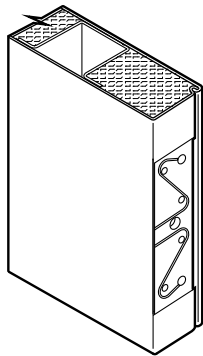

Universal Mortise Hinge Prep
7 Gauge Universal hinge reinforcement

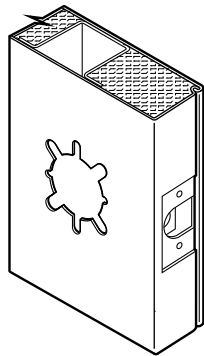

61L Lock

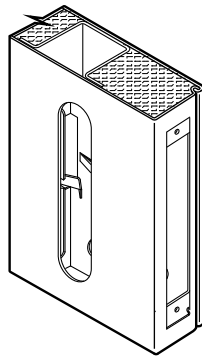

86 Lock

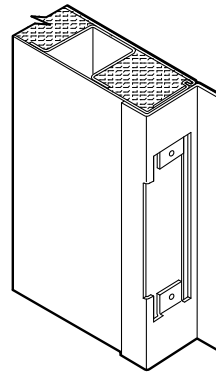

Inactive Leaf ASA Strike Prep with Astragal attached

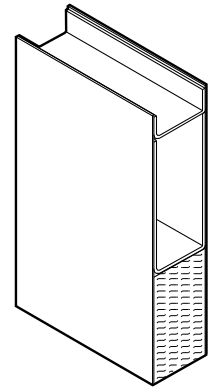

Optional 14 Gauge Closer Reinforcement

Standard: mortised and reinforced for:

- Patented Universal hinge preparations allow for easy field conversion from standard 4 1/2" x .134" standard weight hinges to 4 1/2" x .180" heavy weight hinges. Optional hinge preparation for 5" x .146" standard weight hinges or for 5" (127 mm) x .190" (4.8 mm) heavy weight hinges is also available.
- The cylindrical 161, 61L and mortise 86 lock preps are the most commonly used active leaf preparations. The 4 7/8" (124 mm) strike prep is the most commonly used inactive leaf preparation.
- Optional reinforcements for surface and concealed Closers are available.
- Special hardware applications are available.

Door Sizes and ANSI A250.8 Conversions

Steelcraft product selection for B Series doors has been matched to ANSI/SDI Level and Model designations.

- In accordance with ANSI A250.8-2014 (SDI 100), core material is not specific to the level or model designations. Core material selection is specified based on preference and application.
- Recommended minimum frame gauge also applies to the frequency of operation of the opening.

Series	ANSI A250.8 - SDI 100			Edge Construction	Edge Maximum Sizes		Recommended Gauge of Frame
	Level	Model	Description		Single	Pair	
Level 2: Heavy Duty Commercial & Institutional							
B18	2	1	Full Flush	Visible	4'0" x 10'0" 1219 mm x 3048 mm	8'0" x 10'0" 2438 mm x 3048 mm	16 Gauge [0.053" (1.3 mm)]
BF18		2	Seamless	Filled			
BW18		2	Seamless	Welded			
Level 3: Extra Heavy Duty Commercial & Institutional							
B16	3	1	Full Flush	Visible	4'0" x 10'0" 1219 mm x 3048 mm	8'0" x 10'0" 2438 mm x 3048 mm	16 Gauge [0.053" (1.3 mm)]
BF16		2	Seamless	Filled			
BW16		2	Seamless	Welded			
Level 4: Maximum Duty Commercial & Institutional							
B14	4	1	Full Flush	Visible	4'0" x 10'0" 1219 mm x 3048 mm	8'0" x 10'0" 2438 mm x 3048 mm	14 Gauge [0.067" (1.7 mm)]
BF14		2	Seamless	Filled			
BW14		2	Seamless	Welded			

Door edge construction

- Vertical edges (both hinge and lock) are beveled 1/8" (3.2 mm) in 2" (51 mm) with a visible seam.
- Top and bottom edges are closed with inverted 14 gauge [0.067" (1.7 mm)] welded channels. Exterior applications require the addition of top caps to protect against the weather
- Optional Edge Seams available in the B Series doors:
 - **BF:** the mechanical edge seam is filled and dressed smooth prior to applying the factory primer.
 - **BW:** the mechanical edge seam is welded and dressed smooth prior to applying the factory primer.

Standard visible edge seam

B Series Visible Seam Features

- Full height mechanical interlock
- Interlock filled with epoxy adhesive
- Visible edge seam

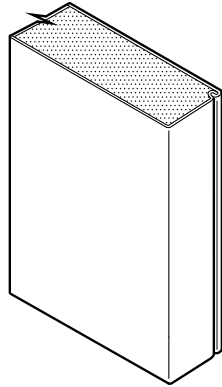

Optional seamless edge

BF Series Seam Filled Features

- Standard Visible Edge Seam is tack welded above and below edge cutouts for hinges, locks, etc.
- Edge Seam is then filled with structural adhesive and dressed smooth
- No visible edge seam

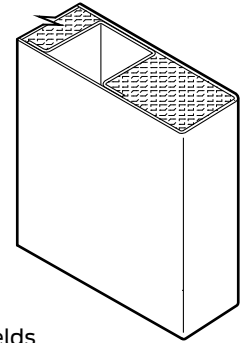

BW Series Seam Welded Features

- Standard Visible Edge Seam is intermittently welded using 1" long welds
- Edge Seam is then filled with structural adhesive and dressed smooth
- No visible edge seam

Glass light options

(Refer to the Lights and Louvers section for further details)

Designer® Trim

- Standard for 1/4" Thick Glass
- Optional for 1/2" Thick Glass

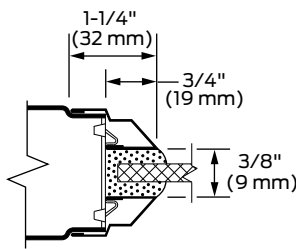

Flush Mounted Steel Trim

- For 1" Thick Glass

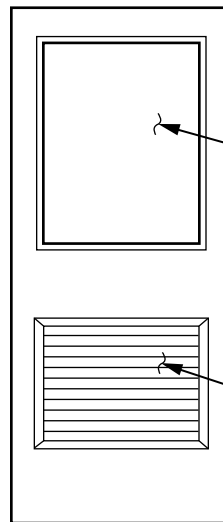
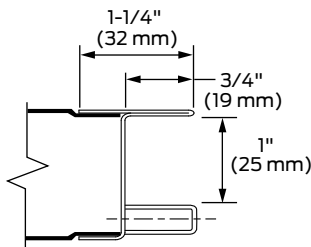

Note: Glazing type and thickness vary per job requirements.

Note: Louver size and type vary per requirements.

Divider Muntins Are Not Available