

RLX Series Cylindrical Lever Locks

Value Product

The RLX Series is a robust Grade 2 lockset with a freewheeling lever operation for enhanced abuse resistance. The RLX is an Arrow Professional Replacement Product featuring removable through bolts and a variety of designs, finishes and functions. The RLX Series cylindrical locksets are a perfect solution for replacing or upgrading locksets in commercial applications.



Certification:

The RLX Series is certified to conform to the requirements of ANSI, A156.2, Series 4000, Grade 2 UL Listed for use on 3 hour, A label single swinging doors.

RLX Levers conform to ADA requirements.



Features:

Construction – Cold rolled steel with zinc dichromate finish for corrosion resistance. Requires standard 2-1/8" (53.97mm) bore through door.

Backset – 2-3/4" (69.85mm)

Door Thickness – Fits 1-3/8" (34.93mm) to 1-3/4" (44.45mm) doors standard.

Latch – Stainless Steel 1/2" (12.7mm) throw, UL Listed, guarded latch-bolt on all locking functions

Latch Front – 1-1/8" x 2-1/4" for 2-3/4" (69.85mm) backset.

Exposed Trim – RLX Levers are pressure cast zinc measuring 4-3/4" (120.65mm) in length. RLX Roses are wrought brass 3-11/32" (84.8mm) diameter. Total projection from face of door is 2-17/32" (64.5mm).



OverDrive™ will allow a locked lever to rotate freely without retracting the latch, improving the life and performance of Arrow locksets.

OverDrive™ – Freewheeling lever action occurs when latch retraction mechanism disengages from lever handle when handle is locked. Built-in stops in the rose insert prevent lever from traveling beyond approximately 45 degrees.

Finishes:

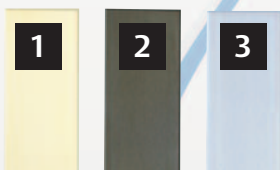

	BHMA	U.S. Equivalent	Arrow Equivalent	Finish
1	605	US3	03	Bright Brass
2	613	US10B	10B	Dark Oxide Bronze, Oil Rubbed
3	626	US26D	26D	Satin Chromium Plated

ADA/Americans with Disabilities Act:

Acceptable Door Hardware: Section 4.13.9

Handles, pulls, latches and other operating devices on accessible doors shall have a shape that is easy to grasp with one hand and does not require grasping, tight pinching or twisting of the wrist to operate. Lever operated mechanisms, push-type mechanisms and "U" shaped handles are acceptable designs.

 Look for the universal symbol next to Arrow products that comply with ADA accessibility requirements.

Strike – 4-7/8" ANSI (123.83mm)

Cylinder – Solid brass 6 pin, Schlage CS keyway, keyed different

Keys – 2 brass keys

Handing – Non-handed

Thru-bolts – Removable thru-bolts standard on RLX Series

Packaging – 6 per case

Warranty – Five Year Mechanical Warranty

RLX Series Cylindrical Lever Locks

Value Product

RLX Series lever designs

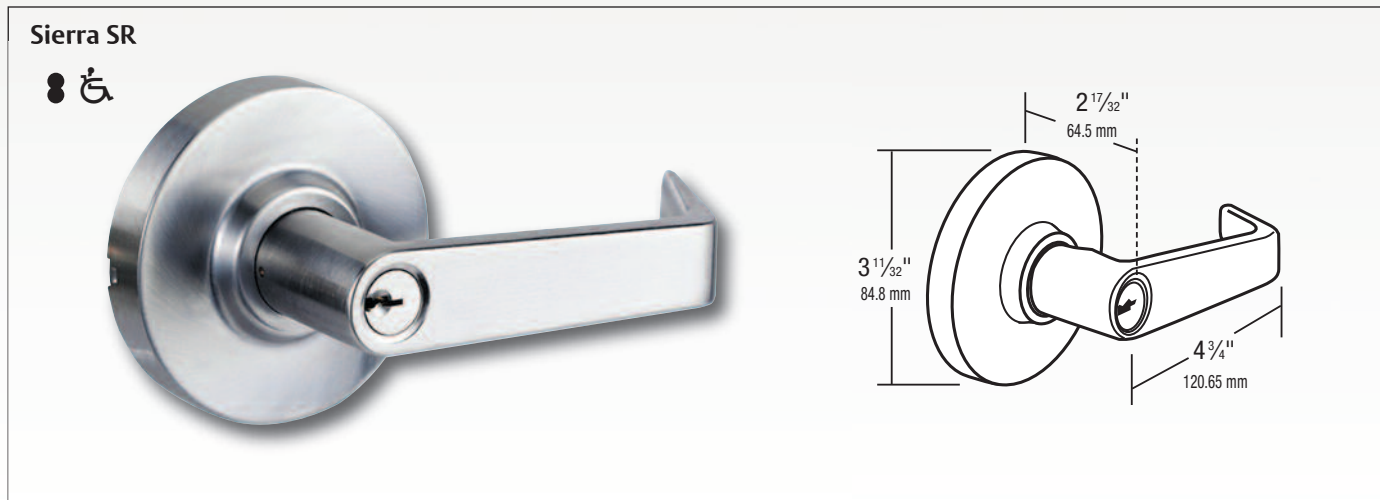

RLX Series cylinders

Solid Brass 6 pin cylinder, pinned. "CS" Keyway standard. Arrow sectional keyways available. Competitive keyways available. US4, US26D finish.

Tailpiece

Part #

1001-44

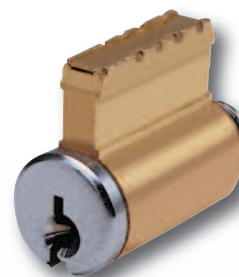



Cylinder Part
#600HD

Interchangeable Core:

- Look for this symbol to indicate availability of product with interchangeable core design.

RLX Series Cylindrical Lever Locks

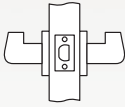
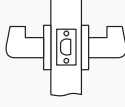
Value Product

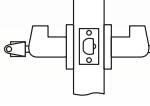
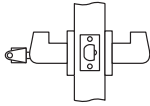
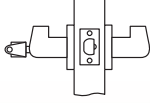
ARROW STANDARD	FUNCTION		DESCRIPTION
RLX01	Passage		Latchbolt operated by lever either side.
RLX02	Privacy		Latchbolt operated by lever either side except when inside turnbutton locks outside. Unlocked by rotating button or by using tool outside.
RLX08	1/2 Dummy Trim		Rigid trim for one side of door only. Used as pull or to match active trim.
RLX81	Entrance		Latchbolt operated by lever either side except when outside lever is locked by turn-button inside. When outside lever is locked, latchbolt operated by key outside or turning inside lever. Inside button must be manually released.
RLX82	Storeroom		Outside lever always locked. Latchbolt operated by key in outside lever, or by turning inside lever.
RLX87	Classroom		Latchbolt operated by lever either side except when key outside locks outside lever. Inside lever always free. Key outside locks/unlocks outside lever only.

RLX Series Cylindrical Lever Locks

Value Product

Latches & Strikes:

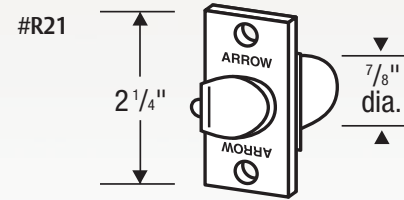
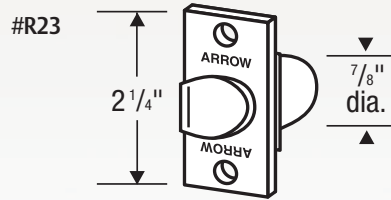

Latch Standards

UL Spring Latches

UL Dead Latches

2-3/4" Backset

#R23

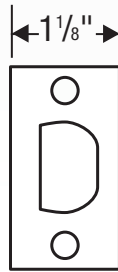

#R21

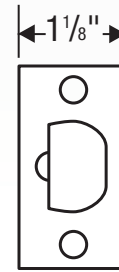

Accessories:

Strikes

306 Strike

Standard with RLX Series

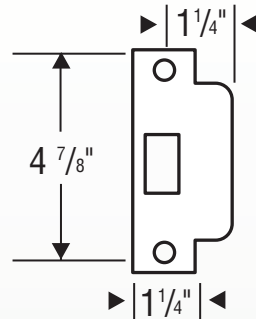

ASA
ANSI 115.2

Installation:

161 prep for retrofit and secure installation.

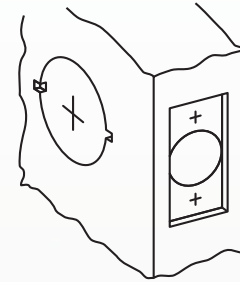

Order Example:

Example: To order a RLX Series entry function lockset with a Sierra design lever, satin stainless steel finish, with an R21 strike, and 2-3/4" deadlocking latch, keyed different:

Specify:

Standard:

RLX
Series

81
Function

SR
Design

26D
Finish

306
Strike

R21
Latch

KD
Keying

XXX
Options
(if required)